

# PHILIPS

AZ 1307 CD Radio Cassette Recorder

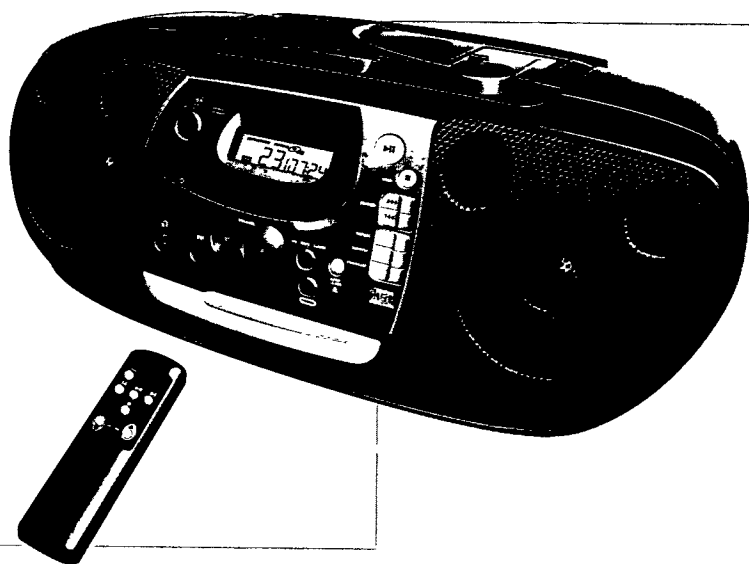

Instructions for use  
Mode d'emploi  
Instrucciones de manejo  
Bedienungsanleitung  
Gebruiksaanwijzing  
Istruzioni per l'uso  
Manual de utilização  
Brugsanvisning  
Bruksanvisning  
Käyttöohje  
Οδηγίες χρήσεως



# PHILIPS

## Important notes for users in the U.K.

### Mains plug

This apparatus is fitted with an approved 13 Amp plug. To change a fuse in this type of plug proceed as follows:

- 1 Remove fuse cover and fuse.
- 2 Fix new fuse which should be a BS1362 5 Amp, A.S.T.A. or BSI approved type.
- 3 Refit the fuse cover.

If the fitted plug is not suitable for your socket outlets, it should be cut off and an appropriate plug fitted in its place. If the mains plug contains a fuse, this should have a value of 5 Amp. If a plug without a fuse is used, the fuse at the distribution board should not be greater than 5 Amp.

*Note: The severed plug must be disposed of to avoid a possible shock hazard should it be inserted into a 13 Amp socket elsewhere.*

### How to connect a plug

The wires in the mains lead are coloured with the following code: blue = neutral (N), brown = live (L). As these colours may not correspond with the colour markings identifying the terminals in your plug, proceed as follows:

- Connect the blue wire to the terminal marked N or coloured black.
- Connect the brown wire to the terminal marked L or coloured red.
- Do not connect either wire to the earth terminal in the plug, marked E (or  $\perp$ ) or coloured green (or green and yellow).

Before replacing the plug cover, make certain that the cord grip is clamped over the sheath of the lead - not simply over the two wires.

### Copyright in the U.K.

Recording and playback of material may require consent. See Copyright Act 1956 and The Performer's Protection Acts 1958 to 1972.

## Norge

Typeskilt finnes på apparatens underside.

**Observer:** Nettbryteren er sekundert innkoplet. Den innebygde nettdelen er derfor ikke frakoplet nettet så lenge apparatet er tilsluttet nettkontakten.

For å redusere faren for brann eller elektrisk støt, skal apparatet ikke utsettes for regn eller fuktighet.

## Deutschland

Hiermit wird bescheinigt, daß dieses Gerät in Übereinstimmung mit den Bestimmungen der Amtsblattverfügung 1046/1984 funktentstört ist.

Der Deutschen Bundespost wurde das Inverkehrbringen dieses Gerätes angezeigt und die Berechtigung zur Überprüfung der Serie auf Einhaltung der Bestimmungen eingeräumt.

## Italia

### DICHIARAZIONE DI CONFORMITA'

Si dichiara che l'apparecchio Lettore CD/Radio-registratore mod. AZ1307 Philips risponde alle prescrizioni dell'art. 2 comma 1 del D. M. 28 Agosto 1995 n. 548.

Fatto a Eindhoven, il 1/10/1996

Philips Sound & Vision  
Philips, Glaslaan 2, SFF 10  
5616 JB Eindhoven, The Netherlands

## France

### WAVE

**BANDS BANDES DE LONGUEURS D'ONDES**  
FM .....MODULATION DE FREQUENCE ou FM  
MW .....ONDES MOYENNES/PETITES ONDES ou PO  
LW .....LONGUES ONDES ou LO

CD.....DISQUE COMPACT ou DISQUE LASER  
**DBB** .....Dynamic Bass Boost :  
suramplification des fréquences basses

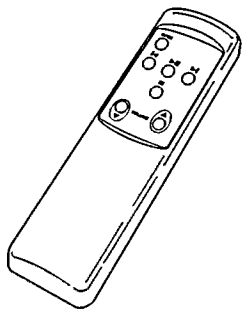
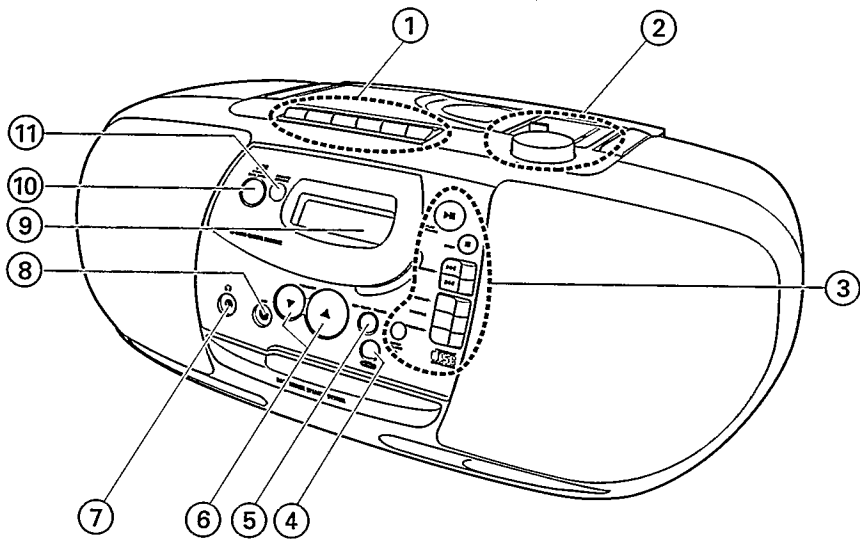

---

---

<b>English</b>	Controls.....	6	CD player.....	9-11	<b>English</b>
	Power supply .....	7	Cassette recorder.....	12-13	
	Basic fuctions .....	8	General information.....	14	
	Tuner .....	8	Troubleshooting .....	15	
<b>Français</b>	Comandes .....	16	Lecteur de CD .....	19-21	<b>Français</b>
	Alimentation.....	17	Platine cassette.....	22-23	
	Fonctions de base.....	28	Informations général.....	24	
	Radio.....	18	Recherche de pannes.....	25	
<b>Español</b>	Controles.....	26	Reproductor CD .....	29-31	<b>Español</b>
	Fuente de alimentación.....	27	Grabadora .....	32-33	
	Funciones básicas.....	28	Información general.....	34	
	Radio.....	28	Localización de averías .....	35	
<b>Deutsch</b>	Bedienungselemente.....	36	CD-Spieler .....	39-41	<b>Deutsch</b>
	Stromversorgung .....	37	Kassetterecorder .....	42-43	
	Grundfunktionen .....	38	Allgemeine Informationen.....	44	
	Radio.....	38	Fehlerbehebung .....	45	
<b>Nederlands</b>	Bedieningstoetsen.....	46	Cd-speler .....	49-51	<b>Nederlands</b>
	Voeding .....	47	Cassetterecorder .....	52-53	
	Basisfuncties .....	48	Algemene informatie.....	54	
	Radio.....	48	Problemen oplossen .....	55	
<b>Italiano</b>	Comandi.....	56	Lettore CD.....	59-61	<b>Italiano</b>
	Alimentazione .....	57	Registratore.....	62-63	
	Funzioni principali.....	58	Informazioni generale.....	64	
	Radio .....	58	Ricerca guasti.....	65	
<b>Svenska</b>	Kontroller .....	66	CD-spelare .....	69-71	<b>Svenska</b>
	Strömförsörjning.....	67	Kassettspelare.....	72-73	
	Basfunktioner.....	68	Allmän information.....	74	
	Radio .....	68	Felsökning .....	75	
<b>Dansk</b>	Betjeningsorganer .....	76	CD-afspiller.....	79-81	<b>Dansk</b>
	Strømforsyning .....	77	Kassettebåndoptager .....	82-83	
	Grundfunktioner.....	78	Generel information.....	84	
	Radio .....	78	Fejlfinding .....	85	
<b>Suomi</b>	Saadot.....	86	CD-soition.....	89-91	<b>Suomi</b>
	Virtalähde .....	87	Kasettinauhuri .....	92-93	
	Perustoiminnot.....	88	Yleistietoja.....	94	
	Radio.....	88	Vianetsintä.....	95	
<b>Português</b>	Comandos .....	96	Leitor CD.....	99-101	<b>Português</b>
	Alimentação.....	97	Gravador de cassetes.....	102-103	
	Funções básicas.....	98	Informações gerais .....	104	
	Radio .....	98	Localização der avarias .....	105	
<b>Έλληνας</b>	Οδηγίες χρήσης.....	106	Φορητό CD .....	109-111	<b>Έλληνας</b>
	Τροφοδοσία.....	107	Κασετόφωνο .....	112-113	
	Βασικές λειτουργίες .....	108	Γενικές πληροφορίες.....	114	
	Ραδιόφωνο.....	108	Ανεύρεση προβλημάτων .....	116	

## ① CASSETTE RECORDER:

- RECORD ● .....to start recording
- PLAY ► .....to start playback
- SEARCH ◀◀ .....to rewind the tape
- SEARCH ▶▶ .....to wind the tape
- STOP-OPEN ■ ▲ .....to stop the tape and to open the cassette compartment
- PAUSE || .....to interrupt recording or playback

## ② TUNER:

- TUNING .....to tune to radio stations
- BAND .....to select the wave band (FM-MW-LW)

## ③ CD PLAYER:

- OPEN-CLOSE ▲ .....to open/close the CD tray
- PLAY-PAUSE ►|| .....to start and to interrupt CD play
- STOP ■ .....to stop CD play and to erase a program
- SEARCH ◀◀ ▶▶ .....to skip and to search forward and backward
- SHUFFLE .....to play in random order
- PROGRAM .....to program track numbers and to review the program
- REPEAT .....to repeat one track or the entire CD or program

## BASIC FUNCTIONS:

- ④ POWER .....to turn the set on and off
- ⑤ CD-TAPE-TUNER ...to select the sound source
- ⑥ VOLUME ▼ ▲ .....to adjust the volume level
- ⑦ ↻ .....3.5 mm headphone socket  
*Note: Inserting the plug will disconnect the speakers.*
- ⑧ MIC .....3.5 mm microphone socket
- ⑨ Display .....Window for showing different playing modes
- ⑩ DBB .....Dynamic Bass Boost
- ⑪ REMOTE SENSOR ..sensor for the infrared remote control

## REMOTE CONTROL:

- OPEN.....to open/close the CD tray
- || .....to start and to interrupt CD play
- ◀▶ .....CD: to select the beginning of the current/previous or a subsequent track
- .....to stop CD play
- VOLUME ▼ ▲ .....to decrease or increase the volume level

# POWER SUPPLY

English

## Batteries

### For the set (optional):

Open the battery compartment of the set and insert six batteries, type **R20**, **UM1** or **D-cells** (preferably alkaline).

### For the remote control (supplied):

Open the battery compartment of the remote control and insert two batteries, type **R06**, **UM3** or **AA-cells** (preferably alkaline).

Remove the batteries if they are flat or the set is not going to be used for a long time.

**Batteries contain chemical substances, therefore they should be disposed of properly.**

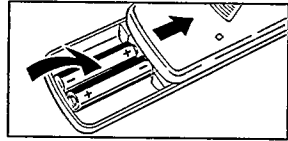
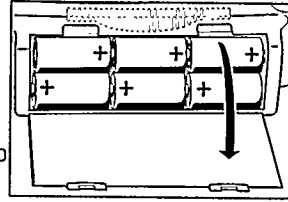

## Mains

1 Check whether the mains voltage as shown on the type plate corresponds to your local mains voltage. If it does not, consult your dealer or service organisation. **The type plate is located on the base of the set.**

If the set is equipped with a VOLTAGE selector (⊗), set this selector to the local mains voltage.

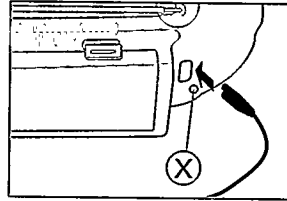

2 Connect the mains cable to the AC MAINS inlet and the wall socket. This switches on the mains supply. **The mains cable is inside the battery compartment.**

The battery supply will be switched off when the set is connected to the mains. To change over to battery supply, pull out the plug from the unit's AC MAINS socket.

To disconnect the set from the mains completely, remove the mains plug from the wall socket.

*For users in the U.K.: please follow the instructions on page 2.*

**To avoid overheating of the set a safety circuit has been built in. Therefore your set may switch off under extreme conditions. If this happens, release the POWER button and let the set cool down before reusing it.**

## Switching on and off/standby

Push the POWER button.  
 → The display lights up.

The set is switched off when the POWER button is released.

In order to switch off the power supply, remove the mains plug.

*Note: If you run the set from batteries, always be sure to switch the set off after use. This will avoid unnecessary power consumption.*

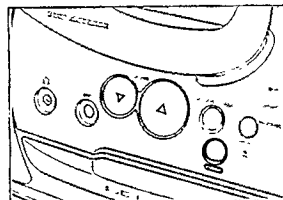

## Adjusting volume and sound

Adjust the volume using the controls VOLUME ▼ ▲.  
 → Display indication: Volume level from 0 to 32.

Increase the bass level by pressing DBB.

→ **DBB** lights up on the display.

Do not cover any vents and leave sufficient room around the unit for ventilation.

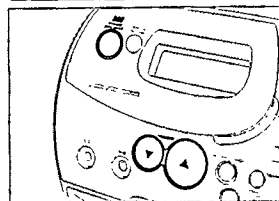
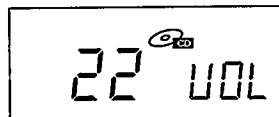

## Tuner – tuning to radio stations

Select the tuner by pressing the CD-TAPE-TUNER button several times until **TUNER** appears on the display.

Select the wave band by using the BAND selector.

Tune to the desired radio station by using the TUNING knob.

### Improving RADIO reception

For **FM**, pull out the telescopic antenna. To improve the signal, incline and turn the antenna. Reduce its length if the signal is too strong (very close to a transmitter).

For **MW** and **LW**, direct the built-in antenna by turning the whole set. The telescopic antenna is not needed.

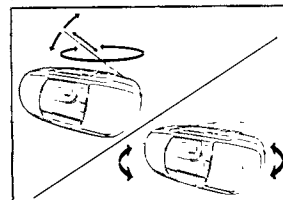
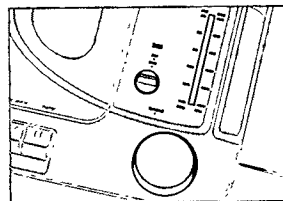



## Playing a CD

- 1 Select the CD player by pressing the CD-TAPE-TUNER button several times until **CD** appears on the display.
- 2 Open the tray by pressing the OPEN-CLOSE **▲** button.
- 3 Insert an audio CD (printed side up) and close the tray by pushing it gently or pressing the OPEN-CLOSE **▲** button again.
  - The CD player starts and scans the contents list of the CD.
  - Display indication: the total number of tracks and the total playing time. After that the CD player stops.
- 4 Press the PLAY-PAUSE **▶||** button to start CD play.
  - Display indication: the current track number and the elapsed time of the current track.
- 5 Press the STOP **■** button to stop CD play.
  - Display indication: the total number of tracks and the total playing time.

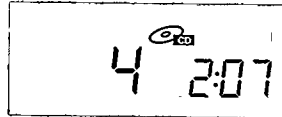
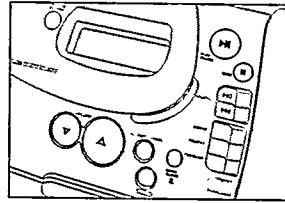

- You can interrupt CD play by pressing PLAY-PAUSE **▶||**. Continue CD play by pressing the button again.
- Display indication: the time where playback was stopped flashes.



*Notes: CD play will also stop if:*

- you open the tray;
- you push the POWER button or
- the end of the CD is reached.

If you make a mistake operating the CD player, or the CD player cannot read the CD, the display indicates *Error* (see TROUBLESHOOTING).

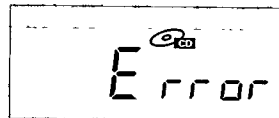

## Environmental information

All redundant packing material has been omitted. We have done our utmost to make the packaging easy separable into three mono materials: cardboard (box), polystyrene foam (buffer) and polyethylene (bags, protective foam sheet).

*Your set consists of material which can be recycled if disassembled by a specialized company. Please observe the local regulations regarding the disposal of packing materials, exhausted batteries and old equipment.*

# CD PLAYER

English

## Search backward ◀◀ and ▶▶ forward

### Selecting another track

Briefly press the SEARCH ◀◀ or ▶▶ button once/several times to skip to the beginning of the current/previous or subsequent track(s).

*During play:*

CD play continues automatically with the selected track.

*From stop position:*

press PLAY-PAUSE ▶▶ to start CD play.

→ Display indication: the selected track number.

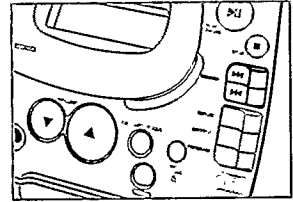

### Searching for a passage during CD play

1 Hold down the SEARCH ◀◀ or ▶▶ button to find a particular passage in a forward or backward direction.

→ CD play continues at a low volume.

2 Release the button when you have reached the desired passage.

*Note: In the SHUFFLE and REPEAT modes and when playing a program, searching is only possible within a particular track.*

## Different playing modes: SHUFFLE / REPEAT

### SHUFFLE – playing in random order

1 Press SHUFFLE before or during CD play.

→ All the tracks of the CD (or program if available) will now be played in random order.

2 To return to normal CD play, press SHUFFLE again.

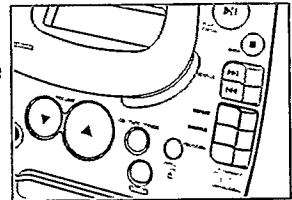

### REPEAT – Repeating the entire CD or one track of the CD

1 Before or during CD play, press repeated REPEAT to cause the display to show the different repeating modes.

→ REPEAT: the current track is played repeatedly.

→ REPEAT ALL: the entire CD or program is played repeatedly.

2 To return to normal CD play press REPEAT until the display indication disappears.

*Note: You can activate the different playing modes at the same time, e. g. you can repeatedly play the entire CD or program in random order (SHUFFLE REPEAT ALL).*



## Programming track numbers

You can select a number of tracks and store these in the memory in the desired sequence. You can store any track more than once. At most, 20 tracks can be stored in the memory.

- 1 Select the desired track with SEARCH ◀◀ or ▶▶.
- 2 As soon as the desired track is displayed, press the PROGRAM button to store the track in the memory.
  - PROGRAM appears in the display. The number of the stored track, Pr, and the total number of stored tracks is shown.
- 3 Select and store all desired tracks in this way.

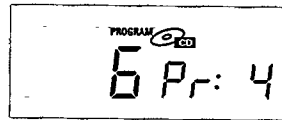
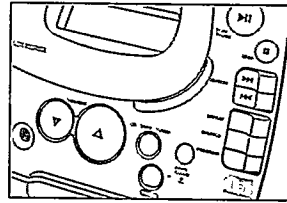

You can review your settings by pressing the PROGRAM button for more than 2 seconds.

- The display shows all stored track numbers in sequence.

*Notes:* – If you try to store more than 20 tracks, the display shows FULL.

– If you press PROGRAM and there is no track selected the display shows SELECT.

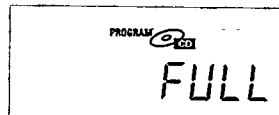

## Playing the program

If you have selected the tracks in the stop position, press PLAY-PAUSE ▶||.

If you have selected the tracks during CD play, first press STOP ■ and then press PLAY-PAUSE ▶||.

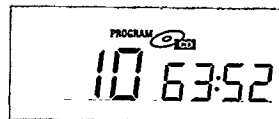

## Erasing the program from the stop position

From the stop position, press STOP ■.

- CLEAR lights up briefly, PROGRAM disappears and your program is erased.

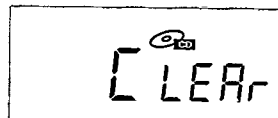

*Notes:* The program will also be erased if you

- interrupt the power supply,
- open the tray, or
- press the POWER button.

# CASSETTE RECORDER

English

## Playing a cassette

- 1 Select the tape by pressing the CD-TAPE-TUNER button several times until **TAPE** appears on the display.
- 2 Press STOP-OPEN ■ ▲ to open the cassette compartment.
- 3 Insert a recorded cassette with the open side facing the front.
- 4 Close the cassette compartment by pushing it down.
- 5 Press PLAY ► to start playback.
- 6 By pressing ◀◀ or ▶▶ fast winding of the tape is possible in both directions.
- 7 To stop the tape press STOP-OPEN ■ ▲.

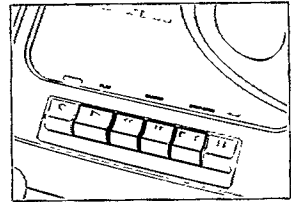

*Notes: – The keys are automatically released at the end of the tape.  
– If PLAY ► or RECORD ● are depressed, you can not switch to another sound source.*

## General information on recording

Recording is permissible insofar as copyright or other rights of third parties are not infringed upon.

For recording on this set you should use a cassette of the type NORMAL (IEC type I). This deck is not suitable for recording on cassettes of the type CHROME (IEC type II) or METAL (IEC type IV).

The recording level is set automatically. The controls VOLUME and DBB do not affect the recording.

At the very beginning and end of the tape, no recording will take place in the 7 seconds during which the leader tape passes the recorder heads.

### Protecting tapes from accidental erasure

Keep the cassette side to be protected in front of you and snap off the left tab. Now, recording on this side is no longer possible.

To record again on this side of the cassette, cover the aperture with a piece of adhesive tape.

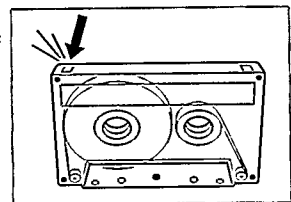

# CASSETTE RECORDER

English

## Recording from the CD player – CD synchro start

- 1 Select the CD by pressing the CD-TAPE-TUNER button several times until **CD** appears on the display.
- 2 Insert a CD and, if desired, program track numbers.
- 3 Press STOP-OPEN ■▲ to open the cassette compartment.
- 4 Insert a blank cassette with the open side facing the front.
- 5 Close the cassette compartment by pushing it down.
- 6 Press RECORD ● to start recording.  
→ Playing of the CD or program starts automatically. It is not necessary to start the CD player separately.
- 7 For brief interruptions, press PAUSE ||. To resume recording, press the PAUSE || key again.
- 8 To stop recording, press STOP-OPEN ■▲.

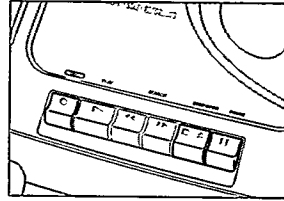

*Notes: the recording can be started from different positions:*

- if the CD player is in the Pause mode, recording will start from this very position (use SEARCH ◀◀ or ▶▶);
- if the CD player is in the Stop mode, recording will start from the beginning of the CD or program.

## Recording from the radio or with the microphone

- 1 (Selecting and preparing the source)

**RADIO:** Select the radio by pressing the CD-TAPE-TUNER button several times until **TUNER** appears on the display.

**MICROPHONE:** Select the tape by pressing the CD-TAPE-TUNER button several times until **TAPE** appears on the display. Connect a microphone with a 3.5 mm plug to the MIC socket and set the VOLUME control to zero (monitoring during microphone recording is not possible).

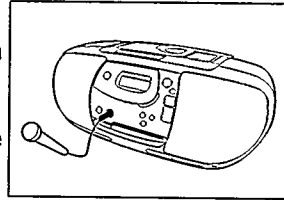

- 2 Press STOP-OPEN ■▲ to open the cassette compartment.
- 3 Insert an unprotected blank cassette with the open side facing the front.
- 4 Press RECORD ● to start recording.
- 5 For brief interruptions press PAUSE ||. To resume recording press the PAUSE || key again.
- 6 To stop recording, press STOP-OPEN ■▲.

*Note: When recording from the radio or a CD, you can connect a microphone and mix the sounds. Otherwise, be sure there is no microphone connected that could disturb your recording.*

# GENERAL INFORMATION

English

## General maintenance

Do not expose the set, batteries, CDs or tapes to humidity, rain, sand or excessive heat (caused by heating equipment or direct sunlight).

The mechanical parts of the set contain self-lubricating bearings and must not be oiled or lubricated!

You can clean the set with a soft, slightly dampened chamois cloth. Do not use any cleaning agents as they may have a corrosive effect.

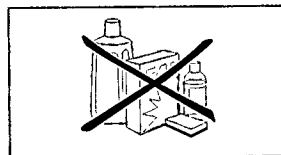
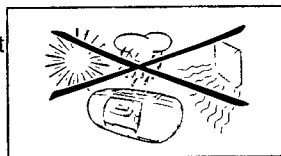

## Tape deck maintenance

To ensure proper recording and playback quality, clean the parts (A)(B)(C) after approx. 50 hours of operation. Use a cotton bud slightly moistened with alcohol or a special head-cleaner fluid.

Press PLAY ► and clean the rubber pressure rollers (C).

Press PAUSE II and clean the capstans (B) and the heads (A).

*Note: Cleaning of the heads (A) can also be done by playing a cleaning tape once.*

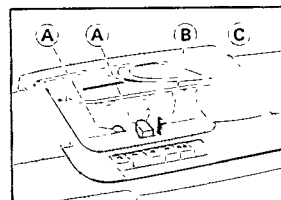

## CD player and CD handling

The lens may cloud over when the set is suddenly moved from cold to warm surroundings. Playing a CD is not possible at such times. Leave the CD player in a warm environment until the moisture evaporates.

To take the CD out of its box easily, press the centre spindle while lifting the CD.

Always pick up the CD by the edge and put it back in its box after use.

To clean the CD, wipe it in a straight line from the center toward the edge using a soft, lint-free cloth. A cleaning agent may damage the disc!

Never write on a CD or attach a sticker to it.

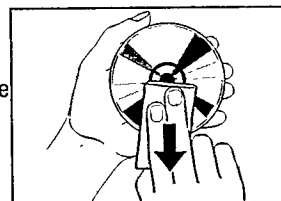
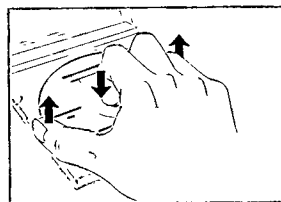

***This set complies with the radio interference requirements of the European Community***

# TROUBLESHOOTING

English

## WARNING

**Under no circumstances should you try to repair the set yourself, as this will invalidate the guarantee.**

If a fault occurs, first check the points listed below before taking the set for repair.

If you are unable to remedy a problem by following these hints, consult your dealer or service center.

PROBLEM	POSSIBLE CAUSE	REMEDY
<b>No sound / no power</b>	VOLUME is not adjusted	Adjust the VOLUME
	Headphone is connected	Disconnect headphone
	Mains cable is not securely connected	Connect the mains cable properly
	Batteries are flat	Replace batteries
	Batteries are incorrectly inserted	Insert the batteries correctly
	Changing over from mains to battery supply without removing the plug	Pull out the mains plug from the unit's AC MAINS inlet
<b>No reaction to operation of any keys</b>	Electrostatic discharge	Disconnect the set from power supply reconnect it after a few seconds
<b>Poor radio reception</b>	Weak radio aerial signal	Aim the aerial for optimum reception: – FM: incline and rotate telescopic antenna – MW/LW: rotate the entire set
	Interference caused by the vicinity of electrical equipment like TVs, video recorders, computers, engines, etc.	Keep the radio away from electrical equipment
<b>no disc or Error indication</b>	The CD is badly scratched or dirty	Replace or clean the CD, see maintenance
	No CD is inserted	Insert a CD
	The CD is inserted upside down	Insert a CD with label upwards
<b>The CD skips tracks</b>	The laser lens is steamed up	Wait until the lens has cleared
	The CD is damaged or dirty	Replace or clean the CD
<b>Poor cassette sound quality</b>	SHUFFLE or PROGRAM is active	Switch off shuffle or program play
	Dust and dirt on the heads, capstan or pressure roller	Clean the heads, capstan and pressure roller, see MAINTENANCE
	Use of unsuitable cassette types (METAL or CHROME)	Only use NORMAL cassettes for recording
<b>Recording does not work</b>	Cassette tab(s) may be snapped off	Apply a piece of adhesive tape over the missing tab space
<b>Remote control does not function properly</b>	Batteries are incorrectly inserted	Insert the batteries correctly
	Batteries are flat	Replace batteries
	Distance to the set is too large	Reduce the distance







English

Français

Español

Deutsch

Nederlands

italiano

Svenska

Dansk

Suomi

Português

Ελληνικά

**CLASS 1  
LASER PRODUCT**

